

via BIMMERPOST.com

Technical training.
Product information.

F30 Entertainment and Communication



BMW Service

Edited for the U.S. market by:
BMW Group University
Technical Training

ST1113

2/1/2012

General information

Symbols used

The following symbol is used in this document to facilitate better comprehension or to draw attention to very important information:



Contains important safety information and information that needs to be observed strictly in order to guarantee the smooth operation of the system.

Information status and national-market versions

BMW Group vehicles meet the requirements of the highest safety and quality standards. Changes in requirements for environmental protection, customer benefits and design render necessary continuous development of systems and components. Consequently, there may be discrepancies between the contents of this document and the vehicles available in the training course.

This document basically relates to the European version of left-hand drive vehicles. Some operating elements or components are arranged differently in right-hand drive vehicles than shown in the graphics in this document. Further differences may arise as a result of the equipment specification in specific markets or countries.

Additional sources of information

Further information on the individual topics can be found in the following:

- Owner's Handbook
- Integrated Service Technical Application.

Contact: conceptinfo@bmw.de

©2011 BMW AG, Munich, Germany

Reprints of this publication or its parts require the written approval of BMW AG, Munich

The information contained in this document forms an integral part of the technical training of the BMW Group and is intended for the trainer and participants in the seminar. Refer to the latest relevant information systems of the BMW Group for any changes/additions to the technical data.

Information status: **September 2011**
VH-23/International Technical Training

F30 Entertainment and Communication

Contents

1. Introduction	1
1.1. F30 bus overview	2
2. Radio and Headunits	5
2.1. Overview of headunits F30	5
2.2. Basic headunit	5
2.2.1. Block diagram	8
2.2.2. System wiring diagram	9
2.3. Car Information Computer (CIC)	11
2.3.1. System wiring diagram	13
3. Speaker Systems	15
3.1. Overview	15
3.2. Components	15
3.2.1. HiFi system	15
3.2.2. Top HiFi system	17
4. Telephone Systems	21
4.1. Overview	21
4.2. System components	21
4.3. General information	22
4.3.1. Compatibility	23
4.4. Hands-free system with USB interface	23
4.4.1. System wiring diagram	23
4.5. Mobile phone preparation with connection for Bluetooth and USB devices	25
4.5.1. System wiring diagram	27
4.5.2. Office	28
5. Video System	32
5.1. Functional diagram	32
6. BMW ConnectedDrive	34
6.1. BMW Online formerly BMW Search	34
6.2. HOW TO ACCESS THE SERVICES	37
7. Personal Profile	39
8. Navigation	41
9. Antenna Systems	42
9.1. Antenna and phase diversity	44

F30 Entertainment and Communication

Contents

9.2.	Bluetooth Antenna.....	45
9.3.	System wiring diagram.....	46

F30 Entertainment and Communication

1. Introduction

The information and communication system plays a significant role in the F30. It can access the highly advanced technology available in the BMW module, which provides the driver with a wide selection of Infotainment systems.

The purpose of this information bulletin is to provide an overview of the following systems:

- Radio and headunits
- Speaker systems
- Telephone systems
- BMW ConnectedDrive
- Antenna Systems.

F30 Entertainment and Communication

1. Introduction

1.1. F30 bus overview

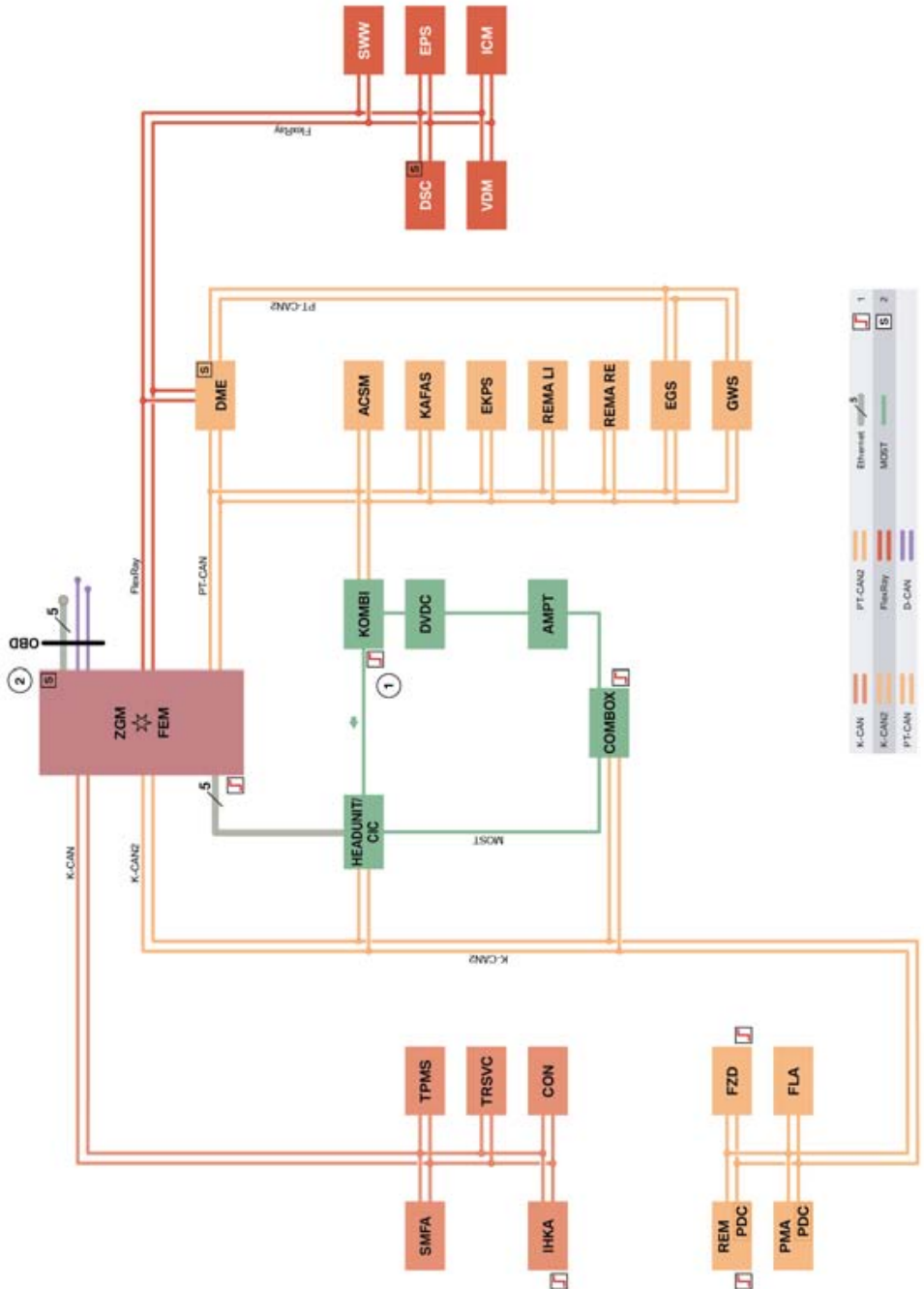

F30 bus overview

F30 Entertainment and Communication

1. Introduction

Index	Explanation
1	Control units with wake-up authorization
2	Start-up node control units for starting and synchronizing the FlexRay bus system
ACSM	Advanced Crash Safety Module
AMPT	Top HiFi amplifier
COMBOX	Combox (Combox emergency call, Multimedia Combox)
CON	Controller
D-CAN	Diagnosis-on-Controller Area Network
DME	Digital Engine Electronics (DME)
DSC	Dynamic Stability Control
DVDC	DVD changer
EGS	Electronic transmission control
EKPS	Electronic fuel pump control
EPS	Electromechanical Power Steering
Ethernet	Cable-based data network technology for local data networks
FEM	Front Electronic Module
FLA	High-beam assistant
FlexRay	Fast, preset and fault-tolerant bus system for use in automotive sector
FZD	Roof function center
GWS	Gear selector lever
HEADUNIT/CIC	Headunit (Car Information Computer or Basic headunit)
ICM	Integrated Chassis Management
IHKA	Integrated automatic heating / air conditioning
K-CAN	Body controller area network
K-CAN2	Body controller area network 2
KAFAS	Camera-based driver assistance systems
KOMBI	Instrument cluster (MOST only with option 6WA)
MOST	Media Oriented System Transport
OBD	On-board diagnosis (diagnostic socket)
PDC	Park Distance Control (with option 5DP, parking manoeuvring assistant: integrated in the parking manoeuvring assistant control unit, otherwise integrated in the Rear Electronic Module control unit)
PMA	Parking manoeuvring assistant
PT-CAN	Powertrain controller area network
PT-CAN2	Powertrain controller area network 2
RAD	Radio

F30 Entertainment and Communication

1. Introduction

Index	Explanation
REM	Rear Electronic Module
REMA LI	Reversible electromotive automatic reel, left (not US)
REMA RE	Reversible electromotive automatic reel, right (not US)
SMFA	Seat module, driver
SWW	Lane change warning
TPMS	Tire pressure control
TRSVK	Control unit for all-round vision camera
VDM	Vertical Dynamics Management
ZGM	Central gateway module

F30 Entertainment and Communication

2. Radio and Headunits

2.1. Overview of headunits F30

Optional equipment	Headunit	CID	Controller	Navigation
Radio (standard)	Basic headunit	6.5"	5-button	No
Navigation system (option 609)	Car Information Computer (CIC)	8.8"	7-button	Yes

2.2. Basic headunit



F30 Basic headunit

Index	Explanation
1	CID
2	Audio system operating facility
3	Basic headunit
4	Controller

The entry level radio for F30 (w/o navigation) is the Basic headunit (HU-B) and is offered as standard equipment.

The controller of the Basic headunit has only five function buttons and can only be toggled to the left and right. The Favorite buttons only have a touch sensor system.

F30 Entertainment and Communication

2. Radio and Headunits

The Basic headunit comes with a central information display (CID) with 6.5" screen.

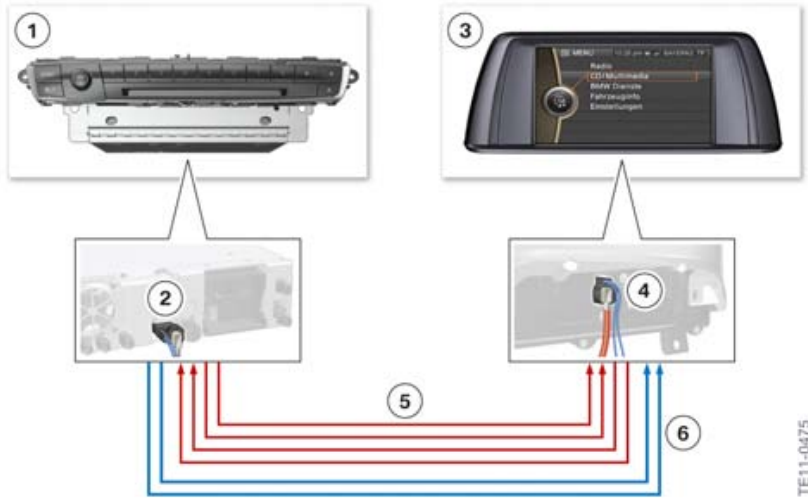

APIX connection, CID to headunit

Index	Explanation
1	Basic headunit
2	APIX jack to Basic headunit
3	Central information display (CID)
4	APIX jack to central information display (CID)
5	APIX data connection lines
6	Power supply

The CID in the F30 is not connected to a bus. The CID is directly connected to the headunit via an APIX interface. APIX (Automotive Pixel Link) is a bit-serial data transfer system with a data transfer rate of 1 Gbit/s on just one copper core pair. Each APIX video link also has a bidirectional reverse channel. Data transfer via the APIX interface has been optimized with regard to electromagnetic compatibility and power consumption.

Because of the CID's low power consumption, the CID can be supplied with power via 2 separate current leads directly by the headunit, and there is no need for a separate power supply to the CID. Because of the high data transfer rate with low electromagnetic emissions, it is also possible to use copper wiring for applications with a high bandwidth requirement and to dispense with fiber optic networking.

The CID is connected via two APIX links to the headunit. The two copper core pairs and the two power supply leads are connected by a common connector to the headunit and the CID. An APIX video link serves to transfer the screen content to the CID. The bidirectional reverse channels of the APIX video links serve to transfer status information (such as e.g. CID operating temperature), diagnostic information and control signals.

F30 Entertainment and Communication

2. Radio and Headunits

In the radio systems area, in addition to an AM/FM double tuner, are integrated in the Basic headunit. In conjunction with the Basic headunit, phase diversity is used instead of the previously customary antenna diversity for FM radio reception. For further information on phase diversity, please refer to the chapter entitled antenna Systems.

In the F30 the Basic headunit has - in conjunction with a mobile phone preparation with connection for Bluetooth and USB devices (option 6NL) - a voice recognition system.

The Telephone function is realized in the headunit and the Contact information is stored on internal memory as there is no removable SD Card.

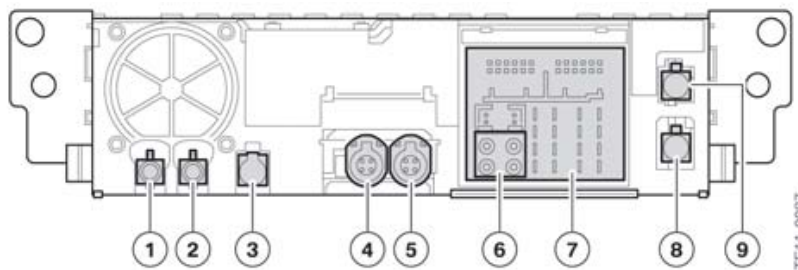

F30 connections, Basic headunit

Index	Explanation
1	AM/FM
2	AM/FM
3	Bluetooth
4	APIX and CID power supply
5	USB
6	MOST
7	Main connector
8	DAB L Band (not US)
9	DAB Band III (not US)

The Basic headunit does not contain any components that are replaceable by a BMW Service agent and has to be replaced completely if defective. The Ethernet connection from the FEM to the headunit is used solely to update the headunit's software.

F30 Entertainment and Communication

2. Radio and Headunits

2.2.1. Block diagram

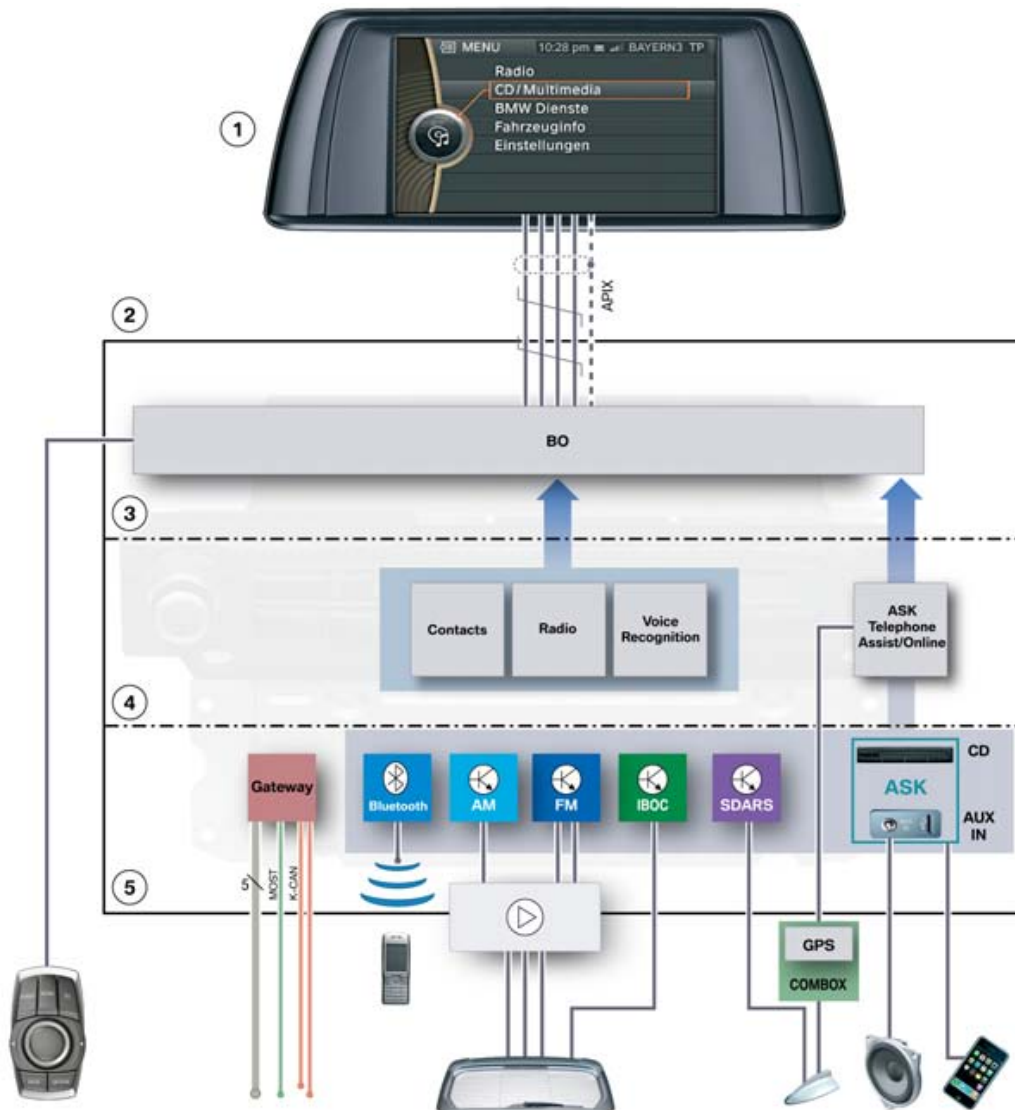

F30 block diagram, Basic headunit

Index	Explanation
1	Central information display
2	Basic headunit
3	User interface
4	Application software
5	Hardware and interfaces

F30 Entertainment and Communication

2. Radio and Headunits

2.2.2. System wiring diagram

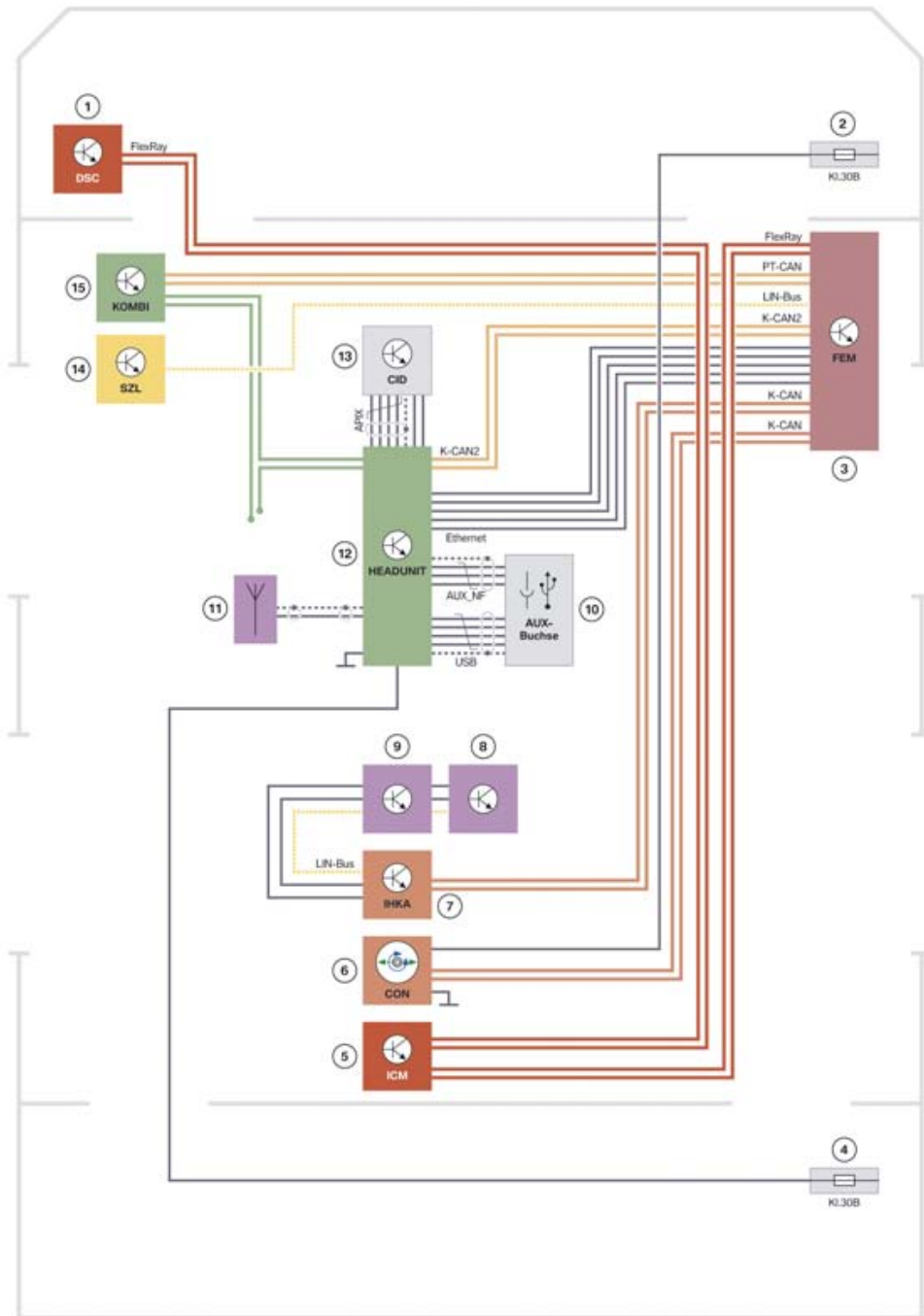

F30 system wiring diagram, Basic headunit

TE11-0058

F30 Entertainment and Communication

2. Radio and Headunits

Index	Explanation
1	Dynamic Stability Control (DSC)
2	Power distribution box, front
3	Front Electronic Module (FEM)
4	Power distribution box, luggage compartment
5	Integrated Chassis Management (ICM)
6	Controller (CON)
7	Integrated automatic heating / air conditioning
8	Audio operating facility
9	IHKA operating facility
10	AUX-In connection with USB audio interface in center console ¹
11	Bluetooth antenna in wiring harness
12	Basic headunit
13	Central information display (CID)
14	Steering column switch cluster (SZL)
15	Instrument cluster (KOMBI)

¹ In vehicles with mobile phone preparation with connection for Bluetooth and USB devices (option 6NL) the AUX-In connection with USB audio interface is connected to the Combox.

F30 Entertainment and Communication

2. Radio and Headunits

2.3. Car Information Computer (CIC)



F30 Car Information Computer

Index	Explanation
1	CID
2	Audio system operating facility
3	Car Information Computer (CIC)
4	Controller

The CIC headunit was installed for the first time in 2008 in the BMW 1 and 3 Series vehicles in conjunction with the Navigation system (option 609). This is now also used in the F30.

The CID in the F30 is not connected to a bus. The CID is, as with the Basic headunit, directly connected to the headunit via an APIX interface. The CID can be supplied with power via two leads directly by the headunit.

In the F30 the CIC always has a voice recognition system. To be able to operate the voice recognition system with the buttons on the steering wheel, it is necessary for the Multifunction for steering wheel to be installed as standard.

The headunit provides, through data management on an 80 GB hard disk, for a multitude of new possibilities.

F30 Entertainment and Communication

2. Radio and Headunits

This is clearly shown in the audio field particularly with the compiling of music. Music files can be converted (ripped) or copied for compiling music on the hard disc. Stored on the CIC-dedicated hard disk, fast access to these music files is ensured at all times. A choice of up to 3700 music files (12 GB) is possible here.

For further information on the Car Information Computer, please refer to the “Car Information Computer CIC” training information.

F30 Entertainment and Communication

2. Radio and Headunits

2.3.1. System wiring diagram

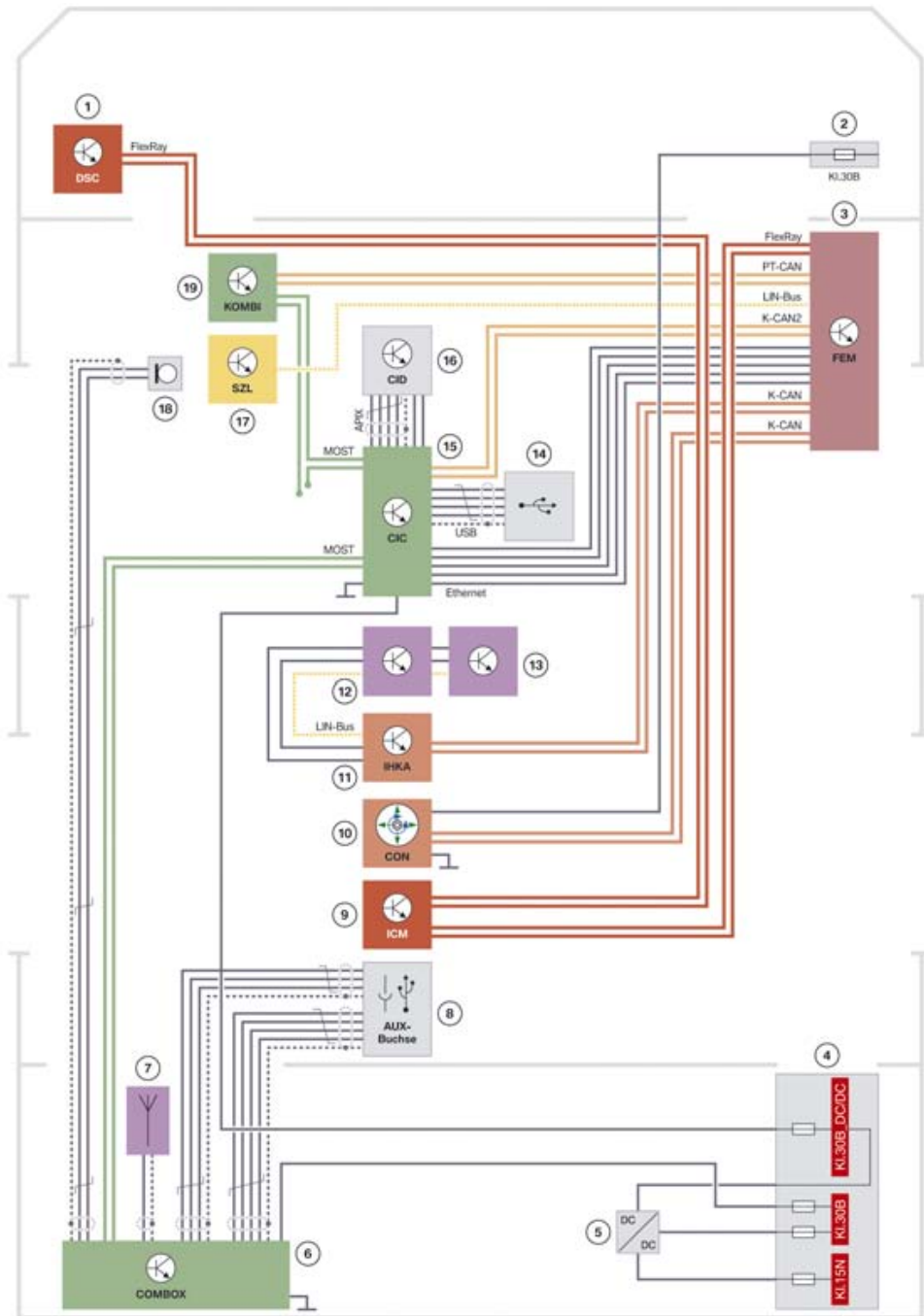

F30 system wiring diagram, Car Information Computer (CIC)

TE11-0054

F30 Entertainment and Communication

2. Radio and Headunits

Index	Explanation
1	Dynamic Stability Control (DSC)
2	Power distribution box, front
3	Front Electronic Module (FEM)
4	Power distribution box, luggage compartment
5	DC/DC converter
6	Combox
7	Bluetooth antenna in wiring harness
8	AUX-In connection with USB audio interface in center console
9	Integrated Chassis Management (ICM)
10	Controller (CON)
11	Integrated automatic heating / air conditioning
12	IHKA operating facility
13	Audio operating facility
14	USB connection in glove box
15	Car Information Computer
16	Central information display (CID)
17	Steering column switch cluster (SZL)
18	Microphone
19	Instrument cluster (KOMBI)

F30 Entertainment and Communication

3. Speaker Systems

3.1. Overview

The speaker systems in the F30 are available in three specification levels:

- HiFi system = HiFi loudspeaker system
- Top HiFi system = HiFi loudspeaker system Harman Kardon (optional equipment 688).

This means the HiFi system is standard equipment.

The speaker and amplifier from the F30 have a similar design to the systems currently used in the 5-Series and 7-Series. The amplifier and headunits have been optimally adapted to the passenger compartment of the F30 through vehicle-specific equalizing.

The two central basses, like in all the current BMW vehicles, are positioned under the front seats, whereby a consistent bass reproduction is possible in the entire vehicle. The necessary housing volume is achieved by connecting the central basses to the side sill.

All systems have an adjustable, speed-dependent volume adjustment, whereby the higher driving noise level is compensated at higher driving speeds.

3.2. Components

3.2.1. HiFi system

The HiFi loudspeaker system consists of nine speakers. A seven-channel amplifier is integrated in the HiFi loudspeaker system. The amplifier of the HiFi system has no bus connection and receives the switch-on signal instead via a separate line.

Separate speakers are installed in the HiFi system for the treble and mid-tone ranges.

The HiFi system also has a significantly louder center bass speaker and a mid-range speaker positioned centrally in the instrument cluster as a center speaker.

The speakers and the amplifier of the HiFi system are illustrated in the following graphic. The speakers are operated with a power output of 5 x 25 watts for the mid-range speakers and tweeters and 2 x 40 watts for the bass speakers.

F30 Entertainment and Communication

3. Speaker Systems

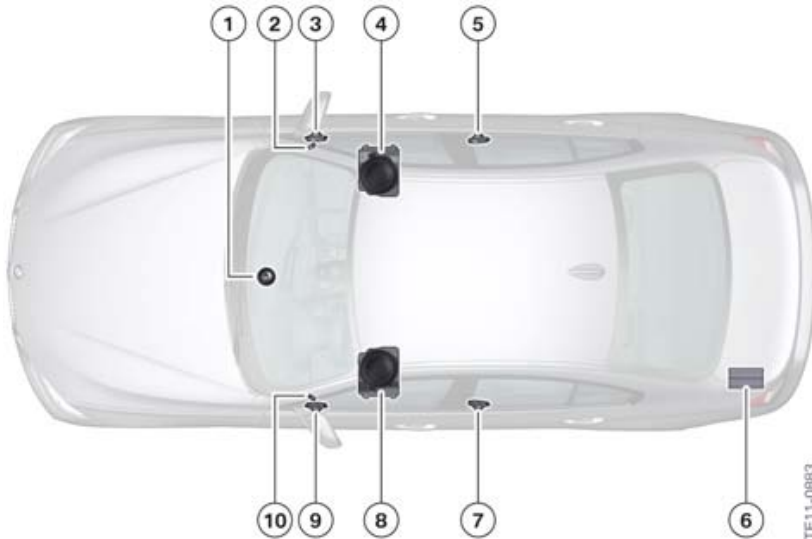

F30 HiFi loudspeaker system

Index	Explanation
1	Mid-range speaker, front center
2	Tweeter, exterior mirror cover, front right
3	Mid-range speaker, front right door
4	Bass speaker under the front right seat
5	Mid-range speaker, rear right door
6	HiFi amplifier
7	Mid-range speaker, rear left door
8	Bass speaker under the front left seat
9	Mid-range speaker, front left door
10	Tweeter, exterior mirror cover, front left

F30 Entertainment and Communication

3. Speaker Systems

3.2.2. Top HiFi system



F30 tweeter, exterior mirror cover

The Harman Kardon HiFi loudspeaker system (optional equipment 688), which has been further optimized in comparison to the HiFi loudspeaker system, is complemented with two additional mid-range speakers and five additional tweeters. The Top HiFi system thus comprises a total of 16 speakers. Incorporated in the Top HiFi system is a nine-channel amplifier with digital equalizing. The AMPT of the Top HiFi system is a bus user in Media Oriented System Transport (MOST).

The mid-range speakers and tweeters of the Top HiFi system have high-quality aluminium diaphragms for a clearly differentiated acoustic pattern. Thanks to the additional use of hexagonally structured metal covers the damping and resonances of the covers are minimized.

The high-quality panels with lettering, which are made from anodized aluminium, in the mirror triangles are a notable visible difference.

The amplifier of the Top HiFi system is equipped with a so-called load logic separator in the F30. Here the amplifier electronics are supplied and connected with a separate voltage line. This is specially protected against brief voltage dips which in turn prevents failure of the electronics if a voltage dip occurs briefly.

The speakers and the amplifier of the Top HiFi system are illustrated in the following graphic. The speakers are operated with a power output of 7 x 50 watts for the mid-range speakers and tweeters and 2 x 125 watts for the bass speakers.

F30 Entertainment and Communication

3. Speaker Systems

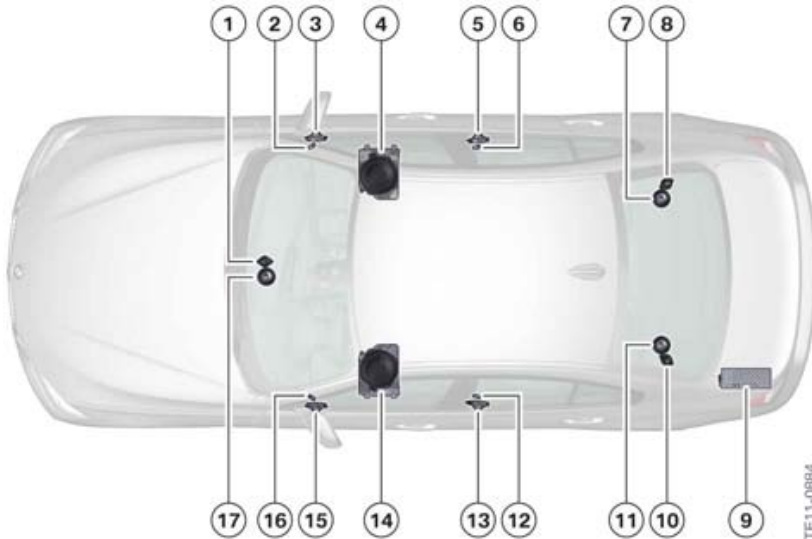

F30 Top HiFi loudspeaker system Harman Kardon

Index	Explanation
1	Tweeter, front center
2	Tweeter, exterior mirror cover, front right
3	Mid-range speaker, front right door
4	Bass speaker under the front right seat
5	Mid-range speaker, rear right door
6	Tweeter, rear right door
7	Mid-range speaker, luggage compartment capping, right
8	Tweeter, luggage compartment capping, right
9	Top HiFi amplifier
10	Tweeter, luggage compartment capping, left
11	Mid-range speaker, luggage compartment capping, left
12	Tweeter, rear left door
13	Mid-range speaker, rear left door
14	Bass speaker under the front left seat
15	Mid-range speaker, front left door
16	Tweeter, exterior mirror cover, front left
17	Mid-range speaker, front center

F30 Entertainment and Communication

3. Speaker Systems

System wiring diagram

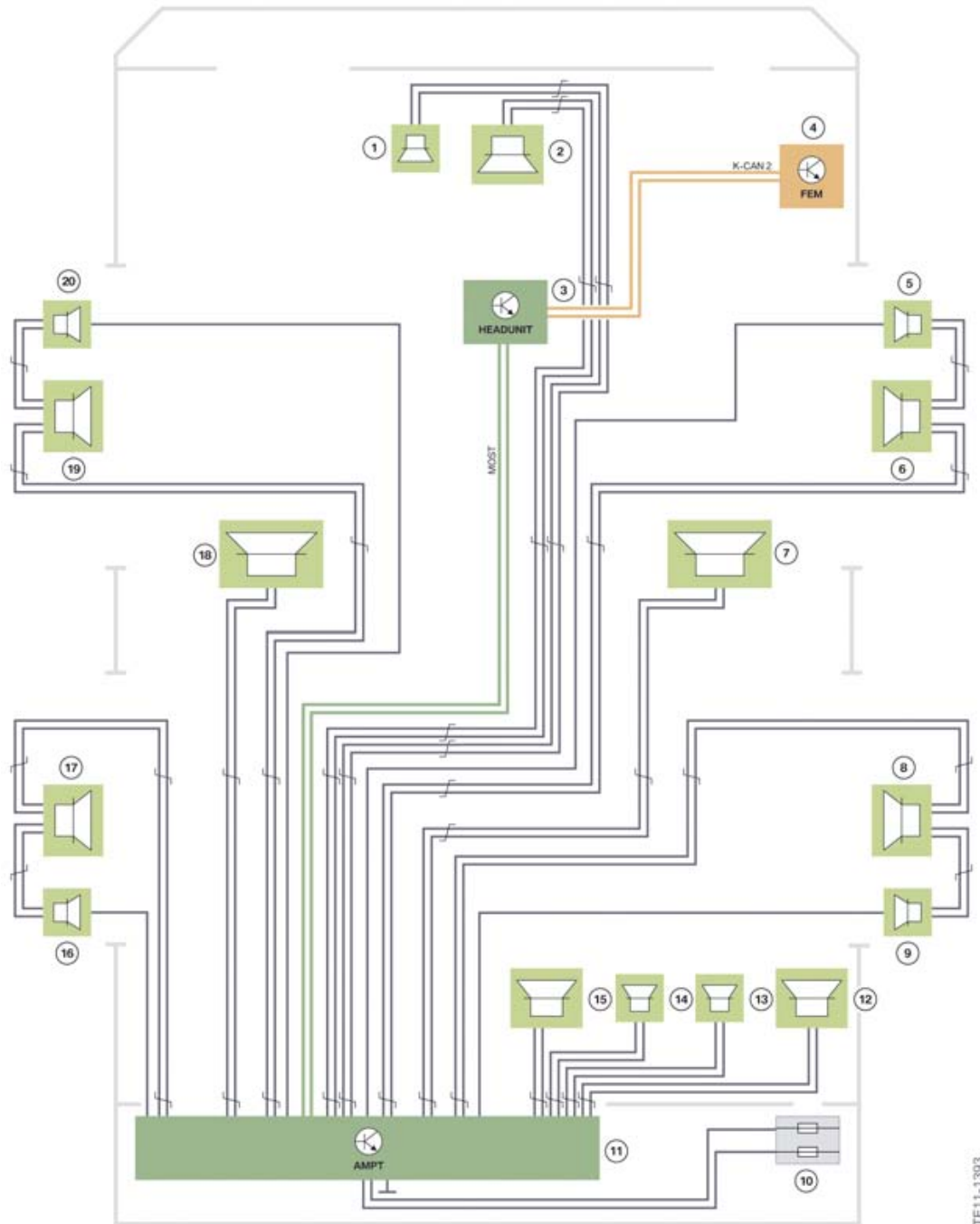

F30 system wiring diagram, Top HiFi system

TE11-1393

F30 Entertainment and Communication

3. Speaker Systems

Index	Explanation
1	Tweeter, front center
2	Mid-range speaker, front center
3	Headunit
4	Front Electronic Module
5	Tweeter, exterior mirror cover, front right
6	Mid-range speaker, front right door
7	Bass speaker under the front right seat
8	Mid-range speaker, rear right door
9	Tweeter, rear right door
10	Power distribution box, luggage compartment
11	Top HiFi amplifier
12	Mid-range speaker, luggage compartment capping, right
13	Tweeter, luggage compartment capping, right
14	Tweeter, luggage compartment capping, left
15	Mid-range speaker, luggage compartment capping, left
16	Tweeter, rear left door
17	Mid-range speaker, rear left door
18	Bass speaker under the front left seat
19	Mid-range speaker, front left door
20	Tweeter, exterior mirror cover, front left

F30 Entertainment and Communication

4. Telephone Systems

4.1. Overview

Three different items of optional equipment are available for the F30 telephone systems:

- Hands-free system with USB interface (standard)
- Mobile phone preparation with connection for Bluetooth and USB devices (option 6NL with telematics).



The specified range of functions is only achieved with BMW-recommended Bluetooth-capable mobile phones. A list of currently recommended Bluetooth-capable mobile phones can be called up through the Aftersales Assistance Portal (ASAP) or at <http://www.bmwusa.com/bluetooth>.

4.2. System components



System components, telephone

TE11-1035

F30 Entertainment and Communication

4. Telephone Systems

Index	Explanation
1	Emergency call speaker (only with option 6NL)
2	Microphone, driver's side
3	Central information display
4	Headunit
5	Controller
6	Base plate (only with option 6NL)
7	Microphone, front passenger side (only with option 6NL)
8	Roof antenna
9	Combox (only with option 6NL or with option 609)
10	Emergency call antenna (only with option 6NL)

The Bluetooth antenna is located in the audio wiring harness of the F30. In the case of a telephone-supported headunit, it is located in the center console. In vehicles with the Combox control unit, it is located in the C-pillar area.

4.3. General information

The telephone functions in the F30 are provided by either the headunit or the Combox. The following table summarizes this information:

Standard/Optional equipment	In conjunction with	Telephone-supported headunit	Combox
Hands-free Bluetooth system with USB interface	Standard equipment (6NH)	Yes	No
BMW Assist with enhanced Bluetooth and USB (option 6NL)	Option 609	No	Combox telematics
BMW Assist with enhanced Bluetooth and USB (option 6NL)	Standard equipment (6NH)	No	Combox telematics with GPS

The optional equipment Navigation System (option 609) always contains telephone functionality in the F30.

The telephone functions contained in the Hands-free Bluetooth system with USB interface (standard equipment 6NH) is installed and realized in the Basic headunit for the standard equipment radio option. In the Basic headunit the Contact information is stored internally as there is no removable SD card installed.

F30 Entertainment and Communication

4. Telephone Systems

4.3.1. Compatibility

The range and diversity of mobile phones available on the market is steadily increasing. Not every Bluetooth-enabled mobile phone is automatically compatible with a hands-free system. The Internet site <http://www.bmwusa.com/bluetooth> has been completely revised to enable the customer to make as easy and clear an enquiry as possible.

The customer can now obtain information regarding the compatibility of specific mobile phones with his vehicle (by entering the vehicle identification number for example). A prospective BMW customer can also find out which mobile phones are compatible with specific BMW models.

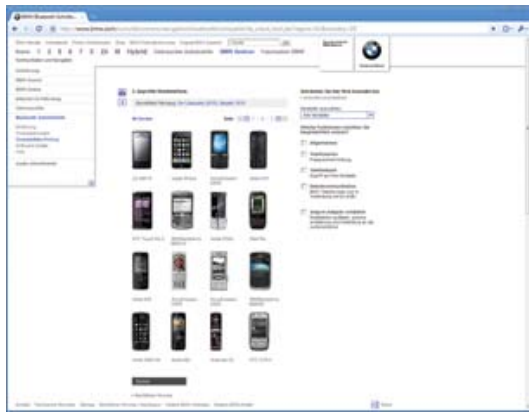

BMW Bluetooth Internet page

4.4. Hands-free system with USB interface

A telephone-supported headunit is used in conjunction with radio (standard equipment) in the F30. With this, no additional control unit is required in order to provide telephone functions in the vehicle.

In vehicles with Navigation System (option 609) a Combox is installed as well as the headunit to achieve the telephone function. In this case, the microphone, the Bluetooth antenna and the AUX-In connection with USB audio interface are connected not to the headunit, but to the Combox.

The functionality and operation of the telephone function follow the established BMW logic. Business Connectivity can be used to pair a wide range of mobile phones via Bluetooth. A list of compatible devices is available at <http://www.bmwusa.com/bluetooth>.

The phone book and lists of callers are transferred from the mobile phone. Contacts can be stored in the address memory of the headunit in addition to the mobile phone's phone book.

During the call the telephone function allows calls to be held or extended (conference call), DTMF tones to be transmitted, and the microphone to be muted.

4.4.1. System wiring diagram

The system wiring diagram for Business Connectivity in conjunction with Navigation System (option 609) is depicted in the system wiring diagram in the section entitled Car Information Computer (CIC).

F30 Entertainment and Communication

4. Telephone Systems

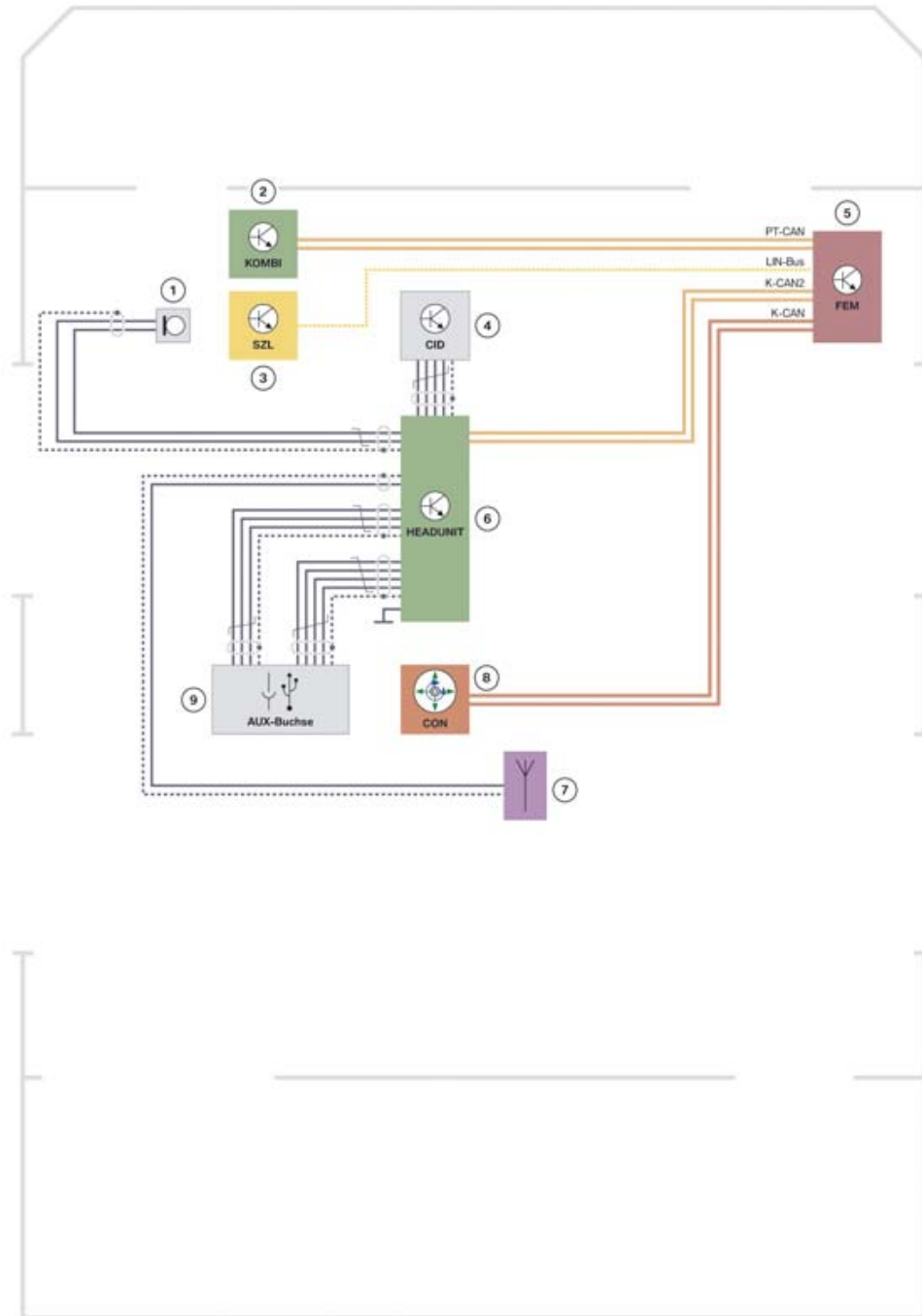

TE11-0056

F30 system wiring diagram, Hands free and Bluetooth/USB standard equipment

F30 Entertainment and Communication

4. Telephone Systems

Index	Explanation
1	Microphone
2	Instrument cluster (KOMBI)
3	Steering column switch cluster (SZL)
4	Central information display (CID)
5	Front Electronic Module (FEM)
6	Headunit
7	Bluetooth antenna in wiring harness
8	Controller (CON)
9	AUX-In connection with USB audio interface in center console

4.5. Mobile phone preparation with connection for Bluetooth and USB devices



F30 mobile phone preparation with AUX-In connection with USB audio interface

Vehicles are equipped with a Multimedia Combox. The Multimedia Combox with telematics board (option 6NL) in conjunction with the Mobile phone preparation with connection for Bluetooth and USB devices. Vehicles have a USB audio interface and two microphones. In addition, a base plate with charger function is used for the connection of the telephone antenna on the roof. In vehicles with the optional equipment Music interface for smartphones (optional equipment 6NF) the base plate is also extended to include a USB data connection to the Combox.

In vehicles with the standard radio equipment the Combox also has a GPS receiver.

F30 Entertainment and Communication

4. Telephone Systems

The following functions are available in the F30 with the Combox:

- Connection of external audio players (e.g. smartphones) via Bluetooth
- Simultaneous pairing of several mobile phones and audio devices via Bluetooth
- Contacts with pictures
- Software updating directly by customer
- Connection of certain iPods via a cable (omission of Y-cable)
- Album cover display (with iPod/MTP player/MP3 via USB)
- Office with email, calendar and notes from mobile phone

F30 Entertainment and Communication

4. Telephone Systems

4.5.1. System wiring diagram

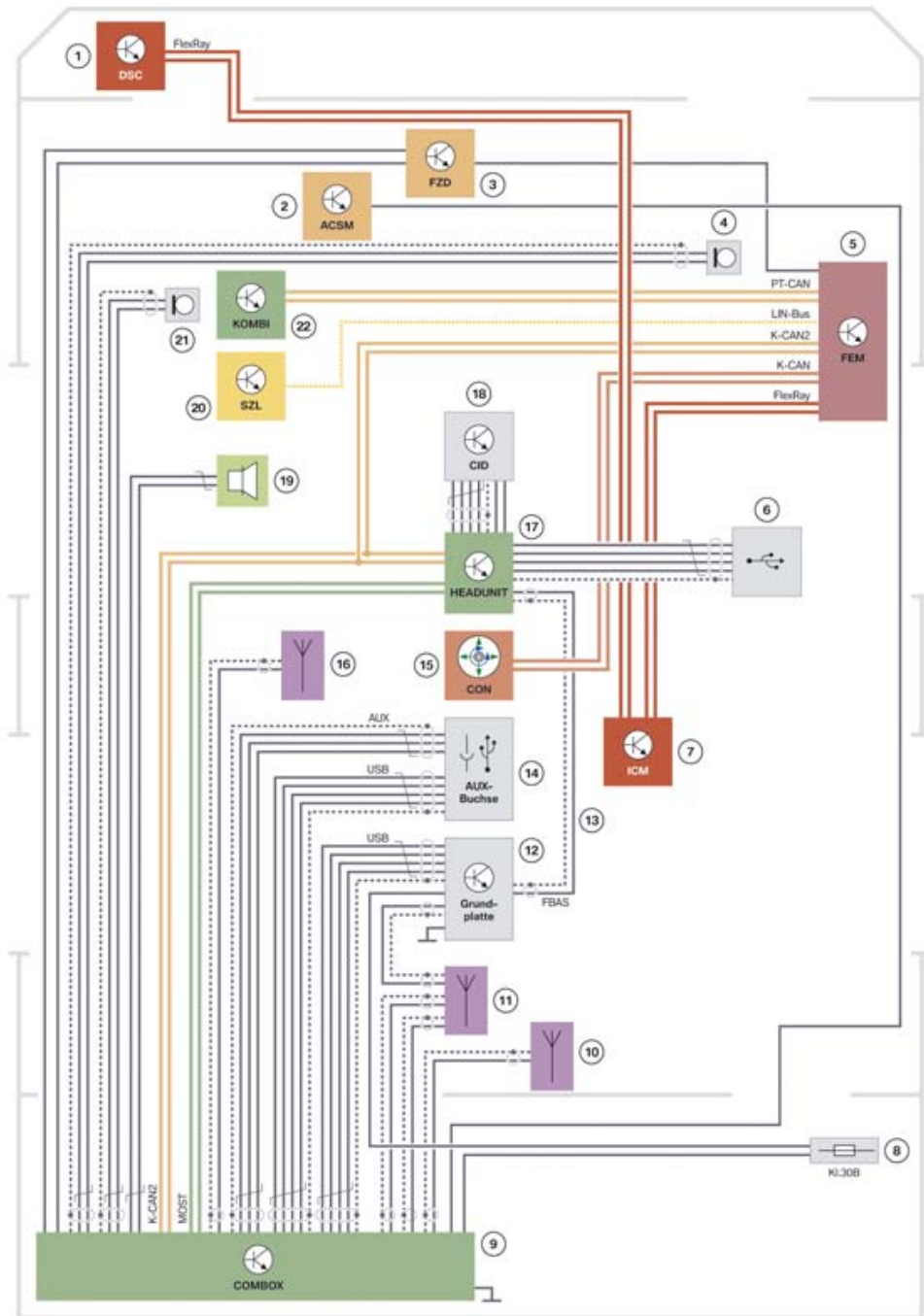

F30 system wiring diagram, Connectivity

TE11-1169

F30 Entertainment and Communication

4. Telephone Systems

Index	Explanation
1	Dynamic Stability Control (DSC)
2	Crash Safety Module (ACSM)
3	Emergency call button in roof function center FZD (option 6NL only)
4	Microphone 1
5	Front Electronic Module (FEM)
6	USB connection in glove box
7	Integrated Chassis Management (ICM)
8	Power distribution box, luggage compartment
9	Combox
10	Emergency GSM antenna (option 6NL only)
11	Roof antenna
12	Base plate (USB data connection and antenna connections only with option 6NF)
13	CVBS video connection to headunit (only in conjunction with option 6NR and option 609)
14	AUX-In connection with USB audio interface
15	Controller (CON)
16	Bluetooth antenna in wiring harness
17	Headunit
18	Central information display (CID)
19	Emergency call speaker (option 6NL only)
20	Steering column switch cluster (SZL)
21	Microphone 2
22	Instrument cluster (KOMBI)

4.5.2. Office

With the optional equipment Mobile phone preparation with connection to Bluetooth and USB devices (6NL), the Combox allows the customer to use the Office function.

The customer can use the Office function to access the SMS, calendar, notes, aimless, tasks and reminders in a compatible mobile phone. The Contacts menu item has been replaced by the Office menu item in the central information display.

The data on the mobile phone can only be read. This means that the data on the mobile phone cannot be modified by the Combox.

The "Office update" display tells the user about the number of new messages, which tasks are active and forthcoming deadlines.

F30 Entertainment and Communication

4. Telephone Systems



Office update display

The calendar can display deadlines of the last 30 days and for the next 90 days.

If an appointment contains phone numbers or email addresses, they can be used directly or saved to the Contacts.



Appointment view

SMS, aimless, appointment entries, tasks and notes can be read out.

Information on the Office functions supported on your mobile phone can be found online at <http://www.bmwusa.com/bluetooth>.

Office for iPhone

On an iPhone the Office functions calendar and email are not supported. The calendar display is currently only possible using an App in connection with optional equipment BMW Apps (optional equipment 6NR).

F30 Entertainment and Communication

4. Telephone Systems

Office for Blackberry

When using the Office function on Blackberry devices please take note of the following four points:

1) Office functions must be supported by the mobile phone. More information is available online at <http://www.bmwusa.com/bluetooth>.



BMW Bluetooth Internet page

2) Office function must be activated in the headunit.



Activation of Office function in Central Information Display (CID)

3) The coding setting of the Blackberry must be deactivated.

4) There must be no more than 500 emails in the inbox of the Blackberry.

F30 Entertainment and Communication

4. Telephone Systems

When using the calendar function an App also has to be installed for the Blackberry.

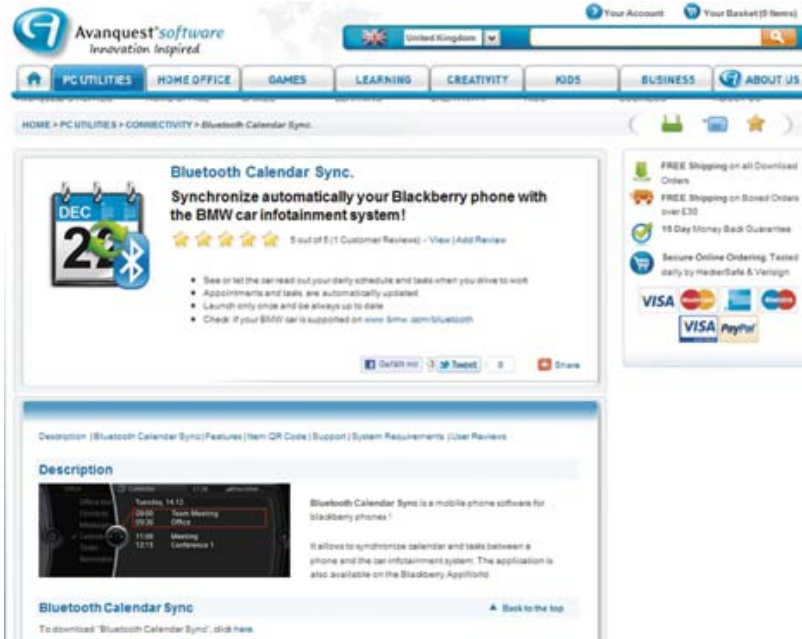

App for calendar function with Blackberry

If the Office functions are not available although all known points are fulfilled, deactivate the Bluetooth connection in the headunit and on the mobile phone. Then reactivate the Bluetooth connection. Information on deactivating and activating the Bluetooth connections is available in the Owner's Handbook and online at <http://www.bmwusa.com/bluetooth>.

F30 Entertainment and Communication

5. Video System

Video from Digital Versatile Disc (DVD) can be viewed in the Central Information Display (CID) of the F30. For safety reasons, the video picture in the CID is switched off during the journey and a note is displayed instead.

The following optional equipment is offered:

- DVD changer for 6 DVDs.

Playing video DVDs with the DVD changer for 6 DVDs is only possible in connection with Navigation System (optional equipment 609).

As well as playing back films, interactive media such as travel guides, reference works, catalogues, etc. can be displayed. Multiple channel audio formats are supported in conjunction with the Top HiFi amplifier (optional equipment 688 HiFi loudspeaker system Harman Kardon).

5.1. Functional diagram

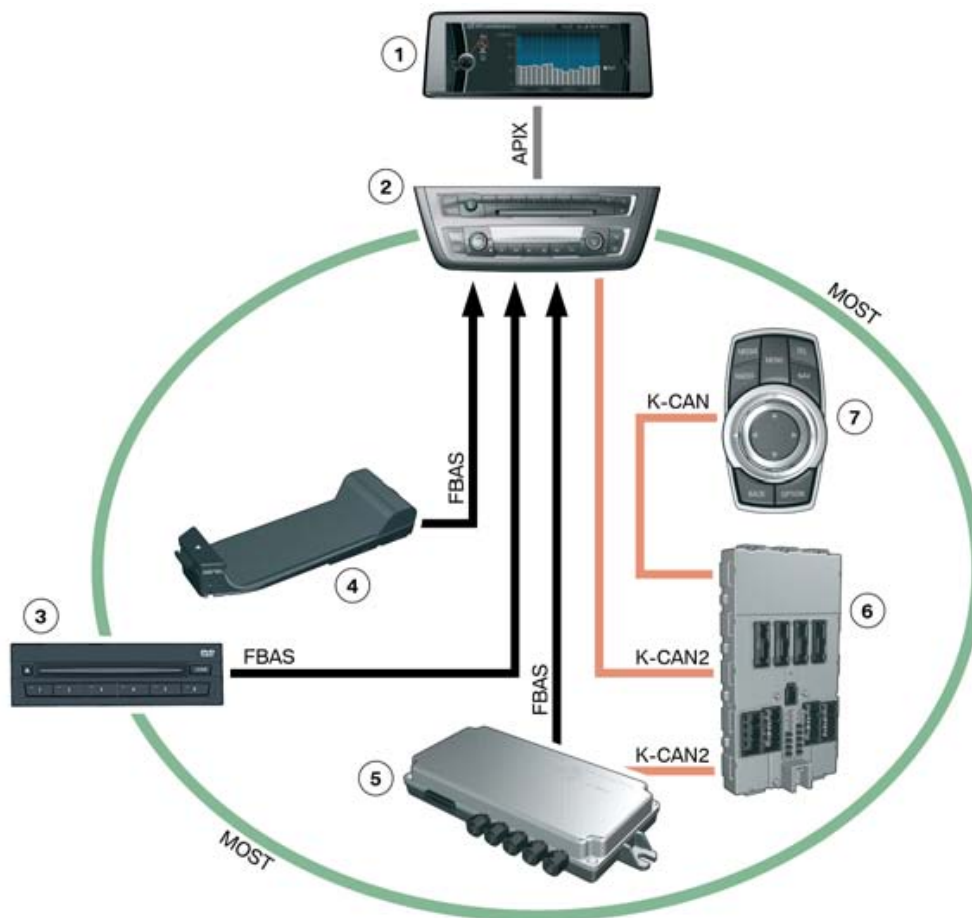

F30 system wiring diagram video function

F30 Entertainment and Communication

5. Video System

Index	Explanation
1	Central information display (CID)
2	Car Information Computer (CIC)
3	6-disc DVD changer, in glove box
4	Base plate with video integration
5	TRSVc control unit
6	Front Electronic Module (FEM)
7	Controller

Three systems are involved as video sources in connection with the Navigation headunit (optional equipment 609) in the F30:

- DVD changer
- TRSVc control unit (with optional equipment 3AG reversing camera or optional equipment 5DL Surround View)
- Base plate with video integration (with optional equipment 6NR BMW Apps).

The transmission of the video data is realized via color Video Blanking Signal (FBAS). The Car Information Computer (CIC) headunit with optional equipment 609 used in the F30 only has three (FBAS) Signal connections, however. As no video switch is available in the F30 only three video sources can be installed.

F30 Entertainment and Communication

6. BMW ConnectedDrive

BMW ConnectedDrive is effectively a personal assistant to the driver. It utilizes the latest technologies with the aim of supplying the driver with all the information that he/she wants and needs. With the market introduction of the F01 the BMW ConnectedDrive has been enhanced with a further innovation: use of the Internet inside the vehicle.

In the F30 many of the BMW ConnectedDrive functions already familiar from current BMW models are used, such as e.g.:

- “BMW Assist” (option 6NL) adds BMW Online service (option 615)
- “Apps” (option 6NR) adds “BMW Assist” (option 6NL)
- “BMW Online service” (option 615)

For some BMW ConnectedDrive services the optional equipment Mobile phone preparation with connection for Bluetooth and USB devices with telematics services (option 6NL) and an active BMW ConnectedDrive agreement are required.

For further information on the optional equipment “Apps” (option 6NR) and the associated video connection of smartphones, please refer to the “Apps/ConnectedDrive” training information.

6.1. BMW Online formally BMW Search

A new improved interface for the service is used in the F30 with the optional equipment BMW Online. The interface can be personalized by the customer better than before and new features and services can be added by the customer.

The optional equipment Mobile phone preparation with connection for Bluetooth and USB devices with telematics services (option 6NL) and an active BMW ConnectedDrive agreement are required for BMW Online functionality.



BMW Online display in the CID

The ConnectedDrive Services team is pleased to announce exciting changes to the BMW Online experience! The BMW Online service brings the latest Stock Indexes, News, Weather, Google Local Search results, Send to Mail, and Fuel Prices to your vehicle’s navigation system. These will be available in the basic view depending on the vehicle equipment. Other applications are available under "Applications".

F30 Entertainment and Communication

6. BMW ConnectedDrive

The respective information is transferred to the vehicle by means of an Internet connection via an on-line portal developed and made available by BMW and shown on the control display of the iDrive operating system. The enhanced offering is available without any additional cost to not only future customers, but also to a variety of customers already registered for BMW ConnectedDrive.

SERVICES INCLUDED:

Stock Indexes - Want to know the Dow Jones, S&P 500 or NASDAQ indices? BMW Online provides these indices right on your control display. News – With BMW Online, the latest US, Business, World, Sports, Entertainment, and BMW news headlines are available to you. They can even be read out automatically by the vehicle's Text-to-Speech feature.



BMW Online News display in the CID

Weather - BMW Online provides the latest 5-day weather forecast and even provides weather advisories and warnings. You can search for weather at your current location, your destination, or any other location in the US.



BMW Online Weather display in the CID

Google Local Search - With Google Local Search, you can search for a business listing to get important information like the address and phone number. Then, you can set the address as a destination in your navigation or call the business via your Bluetooth-connected phone.



BMW Online Google display in the CID

F30 Entertainment and Communication

6. BMW ConnectedDrive

Fuel Prices - The latest fuel price information is just a few clicks away! With BMW Online, you can search for fuel stations nearby and sort by price or distance.

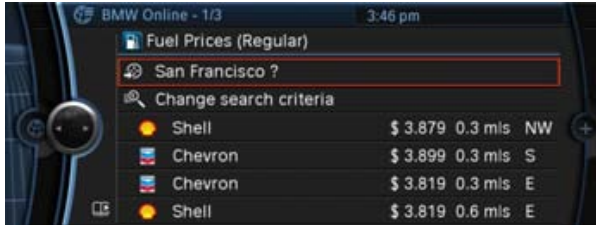

BMW Online Fuel price display in the CID

Send to Mail - With the Send to Mail application, you can email your vehicle's current location and destination to any email address.

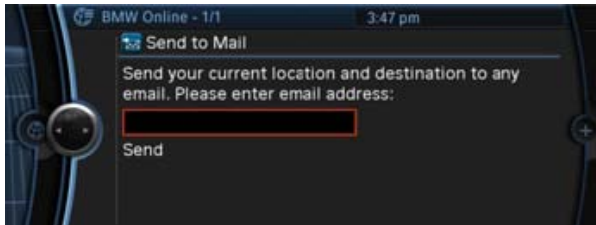

BMW Online Send to Mail display in the CID

The F30 will have the updated BMW Online display screen from the start of production. All current BMW vehicles with this option will have these new screens starting December 1, 2011. This will be automatically updated when opening the online features after December 1st on all vehicles.

Changes Starting December 1, 2011



Display Before December 1, 2011

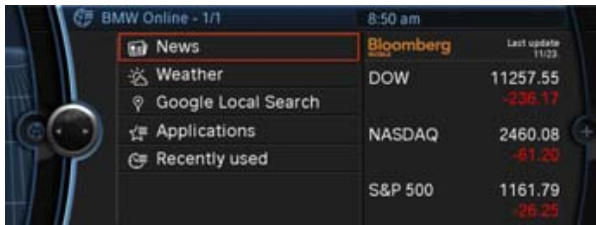

Display Starting December 1, 2011

F30 Entertainment and Communication

6. BMW ConnectedDrive

HOW TO START BMW ONLINE:

For all cars produced before March 2011, and X vehicles produced before April 2011:

Step 1: From the main iDrive menu, select BMW Assist

Step 2: Once in the BMW Assist menu, select BMW Search

Step 3: After a brief moment, the vehicle connects to the BMW Online service

Step 4: You may now see a Welcome screen. If so, select the “Now” text to proceed. Then, you will now be connected to BMW Online

Step 5: Please allow a moment for the service to connect, and then you will see the main menu screen

For all cars produced after March 2011, and X vehicles produced after April 2011:

Step 1: From the main iDrive menu, select ConnectedDrive

Step 2: Once in the ConnectedDrive menu, select BMW Online

Step 3: After a brief moment, the vehicle connects to the BMW Online service

Step 4: You may now see a Welcome screen. If so, select the “Now” text to proceed. Then, you will now be connected to BMW Online

Step 5: Please allow a moment for the service to connect, and then you will see the main menu screen

6.2. HOW TO ACCESS THE SERVICES

News, Weather, and Google Local Search Once you are connected to the BMW Online service, you will be able to access News, Weather, and Google Local Search directly from the main menu.

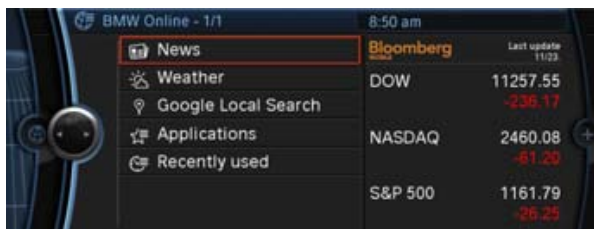

BMW Online Main Menu display in the CID

Other Applications (Fuel Prices, Send to Mail) Some Applications are not shown on the main menu and instead are available via the Applications menu. To use these applications, you must add them to your Applications menu.

F30 Entertainment and Communication

6. BMW ConnectedDrive

HOW TO ADD AN APPLICATION

New applications will be added periodically to BMW Online. In order to get these applications, you must add them via the Applications menu.

Step 1: Select the Applications menu



Step 2: Select the Applications button from the upper-right corner

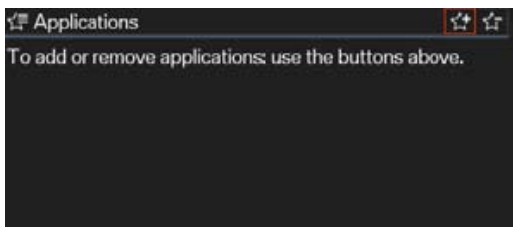

Step 3: On the “Add application” menu, select the application to add

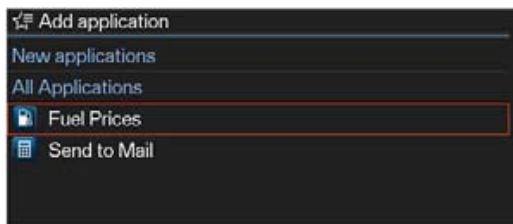

Step 4: On the next screen, you will see a description of the application. Select “Add” to add the application.

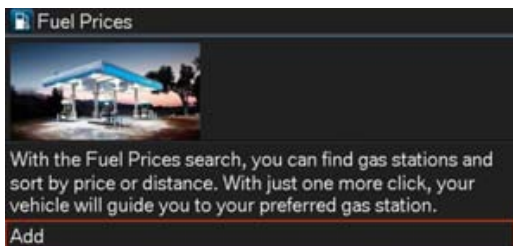

Step 5: You will now be able to access the application, under the “Applications” menu in the main menu.

F30 Entertainment and Communication

7. Personal Profile

Personal Profile stores personally input data, such as e.g. the automatic setting of the exterior mirrors or the speed-dependent volume, in the corresponding control units.

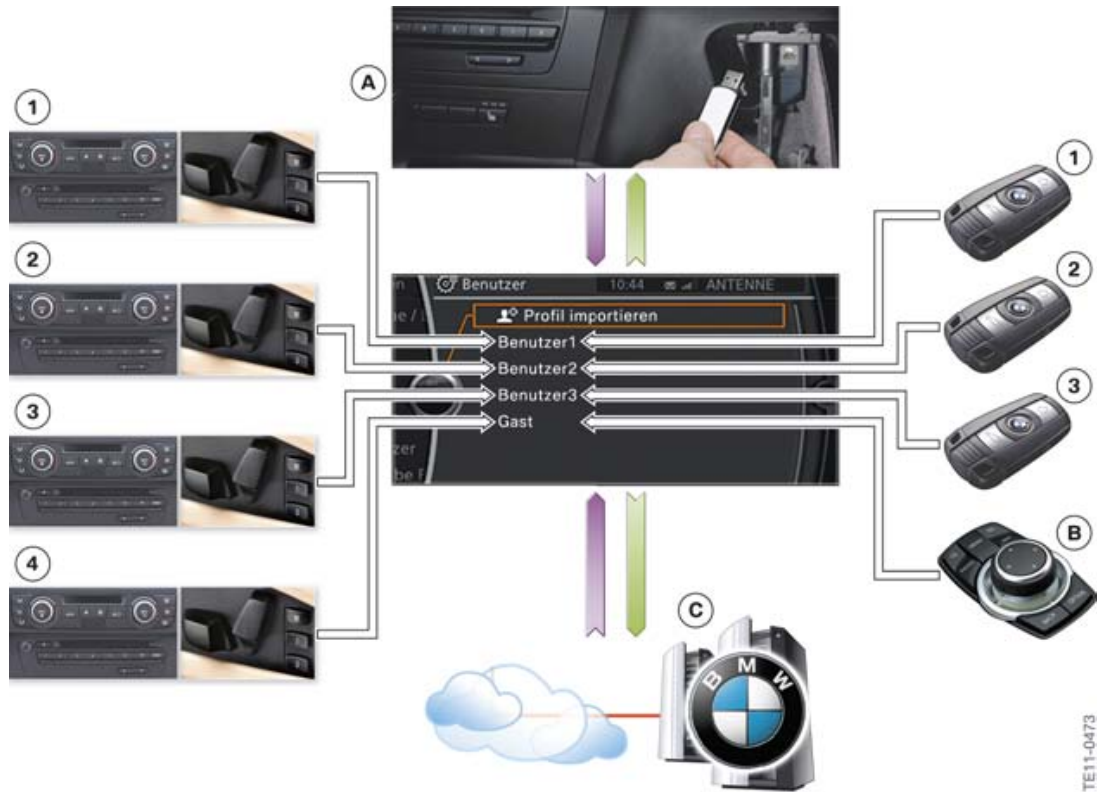

Personal Profile operating principle

Index	Explanation
A	Import/export via USB interface
B	Controller
C	Import/export via BMW Online
1	User profile 1 connected with an ID transmitter
2	User profile 2 connected with an ID transmitter
3	User profile 3 connected with an ID transmitter
4	Guest profile can only be selected via the controller

There is a total of four profiles in the vehicle. Three of these can be adapted for different persons and assigned to different ID transmitters. Once the vehicle is unlocked via the ID transmitter, the system recognizes the profile assigned to the ID transmitter and activates it.

A guest profile can be activated in addition to the three profiles which can be assigned to ID transmitters. The guest profile can be used to make individual settings without affecting the three personal profiles. The guest profile can be activated in the Settings menu in the CID.

F30 Entertainment and Communication

7. Personal Profile



Information for Service:

When receiving a vehicle with Personal Profile, it is important to ensure that the guest profile is activated. In this way, the settings made by the vehicle user are not altered.

Profiles can be imported and exported by means of the USB interface or BMW Online. Which USB port can be used to import and export the profiles is dependent on the vehicle's equipment specification:

Optional equipment	In conjunction with	USB port
Navigation System (option 609)	-	Glove box
Radio (standard)	Hands-free system with USB interface (option 6NH)	Center console
Radio (standard)	Mobile phone preparation with connection for Bluetooth and USB devices (option 6NL)	No import/export via USB possible

Personal profile is always stored in the headunit. Vehicles with navigation (option 609) have a USB port in the glovebox to perform import/export of data.

With the standard radio in combination with the Hands-free system with USB interface (option 6NH), personal profile can be imported/exported through the USB connection in the center console because this is connected to the headunit.

With the standard radio in combination with the Mobile phone preparation with connection for Bluetooth and USB devices (option 6NL) it is not possible to import/export through the USB connection in the center console because this is connected to the Combox and not the headunit.

Exported profiles can also be imported to other vehicles. Which settings of the profiles are adopted during import to another vehicle is dependent on the vehicle model and its equipment specification. During import only settings of functions which are identical in both vehicles are adopted. If a setting cannot be imported, the current setting of the existing profile is retained.



Personal Profile settings in the CID

F30 Entertainment and Communication

8. Navigation

Map updating for navigation is performed in the F30 via a USB interface which is connected to the headunit. The USB port in glove box must be used for map updating. In vehicles with the USB port in the center console, this cannot be used for map updating since the USB is connected to the COM-BOX.

Optional equipment	In conjunction with	Map updating
Navigation System (option 609)	-	USB connection in glove box

F30 Entertainment and Communication

9. Antenna Systems

The F30 has different antenna systems, depending on the national-market version and optional equipment used:

Antenna	System	Location
FM/AM antenna	Radio	Lower
SDARS antenna	Radio	Roof
GPS antenna	Navigation system or Combox	Roof antenna
Remote control services antenna	CAS (remote control services)	Partition wall of luggage compartment, top
Bluetooth antenna	Telephone	Wiring harness
Emergency call antenna	Telematics services	Partition wall of luggage compartment, top

Antenna diversity is used in vehicles with Navigation system (optional equipment 609), while phase diversity is used in vehicles with the standard radio equipment.

The remote control service Antenna and the emergency call antenna are located above at the partition wall to the luggage compartment in the F30.

The following graphic provides an overview of the antenna system components.



F30 Antenna system

F30 Entertainment and Communication

9. Antenna Systems

Index	Explanation
1	Roof antenna
2	Antenna diversity/Phase diversity
3	Wave trap, heated rear window
4	Emergency call antenna
5	Remote control services antenna
6	Interference suppression filter, audio/additional brake light

You can see the layout of the antennas in the rear window on the following graphic.

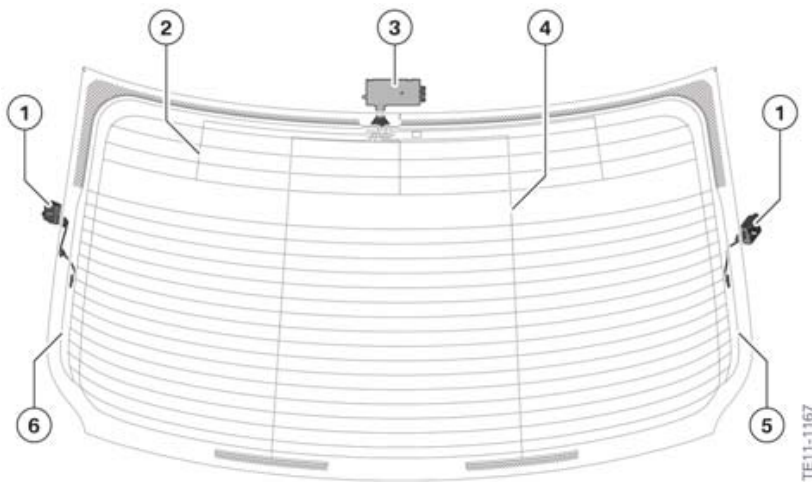

F30 Antenna system, rear window

Index	Explanation
1	Connection of heated rear window to wave trap
2	AM antenna
3	Antenna diversity/Phase diversity
4	DAB Band III antenna (not US)
5	Antenna FM1
6	Antenna FM2

F30 Entertainment and Communication

9. Antenna Systems

9.1. Antenna and phase diversity

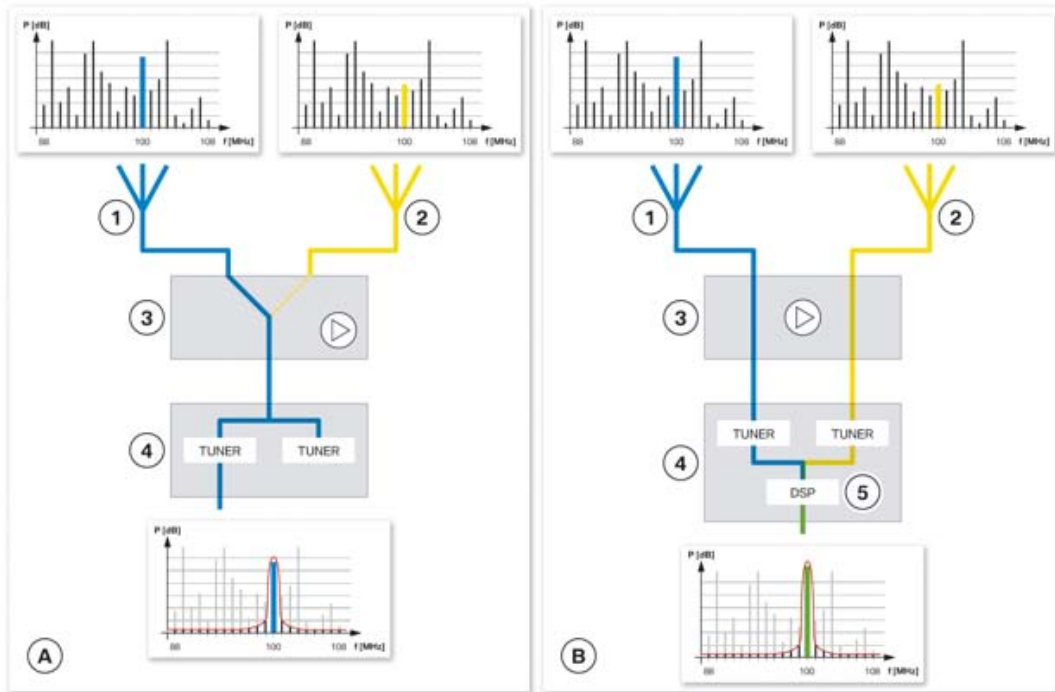

Operating principle, antenna and phase diversity

Index	Explanation
A	Antenna diversity with (option 609) Navigation
B	Phase diversity (standard radio)
1	Antenna signal strong
2	Antenna signal weak
3	Diversity including amplifier
4	Tuner module in headunit
5	Digital signal processor (DSP)

Vehicles with Navigation (option 609) are equipped with antenna diversity. The antenna diversity boosts the signals of the two FM antennas and evaluates the signal levels of the two radio signals. The antenna with the better input signal is used for radio reception. The system switches to the other FM antenna if the signal quality of the received radio station is inadequate in terms of quality and field strength. The switch-on signal for the antenna diversity and the power supply is made available to the antenna diversity via the interference suppression filter of the additional brake light.

Vehicles with the standard radio equipment are equipped with phase diversity. The radio signals of the two FM antennas are boosted in the phase diversity module and transmitted to the Basic headunit. The radio signals are digitized in the Basic headunit. An improved signal is then calculated from the two radio signals with the aid of an algorithm in a digital signal processor (DSP). The switch-on signal

F30 Entertainment and Communication

9. Antenna Systems

for the phase diversity and the power supply is made available by the headunit. For updating the list of stations only the signal from one antenna is used briefly for radio reception and the signal from the other antenna is used for scanning the frequencies. The interval for updating the list of stations depends on the signal quality of the stronger antenna, but occurs at the latest every four minutes.

9.2. Bluetooth Antenna

The Bluetooth antenna for the F30 is conceived as an open item and supplied as part of the wiring harness. A non-connected antenna can no longer be identified by this design. In vehicles which do not have a Combox the Bluetooth antenna is located under the center console. In vehicles which do have a Combox the Bluetooth antenna is located in the area of the left C-pillar

F30 Entertainment and Communication

9. Antenna Systems

9.3. System wiring diagram

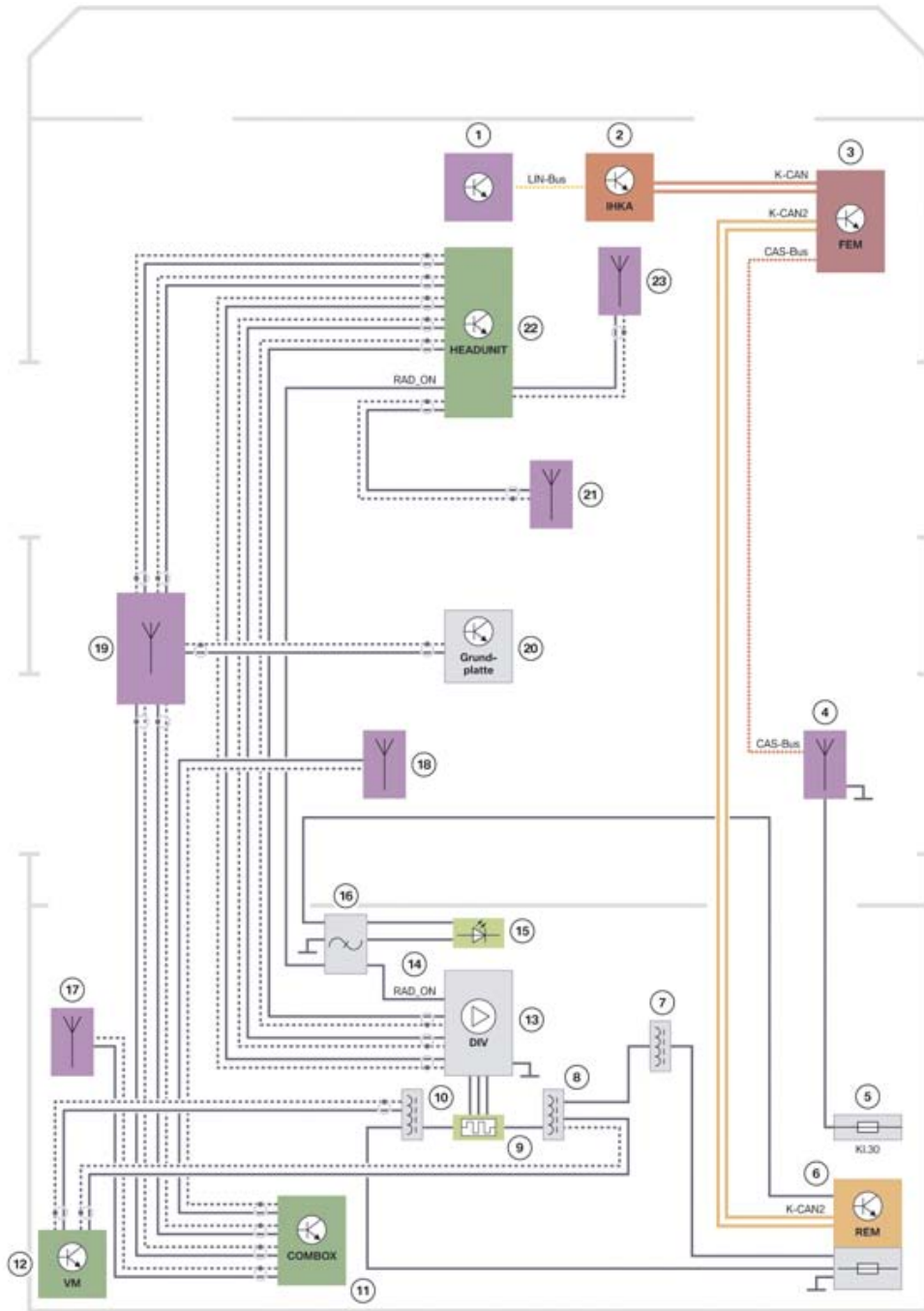

System wiring diagram, antennas in the F30

TE11-0586

F30 Entertainment and Communication

9. Antenna Systems

Index	Explanation
1	Operating facility, integrated automatic heating / air conditioning (IHKA)
2	Integrated automatic heating / air conditioning (IHKA)
3	Front Electronic Module (FEM)
4	Remote control services antenna
5	Power distribution box, luggage compartment
6	Rear Electronic Module (REM)
7	Wave trap, heated rear window
8	Connection of heated rear window to wave trap
9	Heated rear window
10	Connection of heated rear window to wave trap
11	Combox
12	Video Module (not US)
13	Antenna/phase diversity (with amplifier)
14	Line for switch-on signal (only in vehicles with antenna diversity)
15	Additional brake light
16	Interference suppression filter, additional brake light
17	Bluetooth antenna in vehicles with COMBOX
18	Emergency call antenna
19	Roof antenna (telephone, SDARS and GPS)
20	Base plate
21	Bluetooth antenna in vehicles without COMBOX
22	Headunit
23	Antenna in inside mirror (VICS) (for Japan only)



Bayerische Motorenwerke Aktiengesellschaft
Händlerqualifizierung und Training
Röntgenstraße 7
85716 Unterschleißheim, Germany